

MOTORS AND CONTROLS

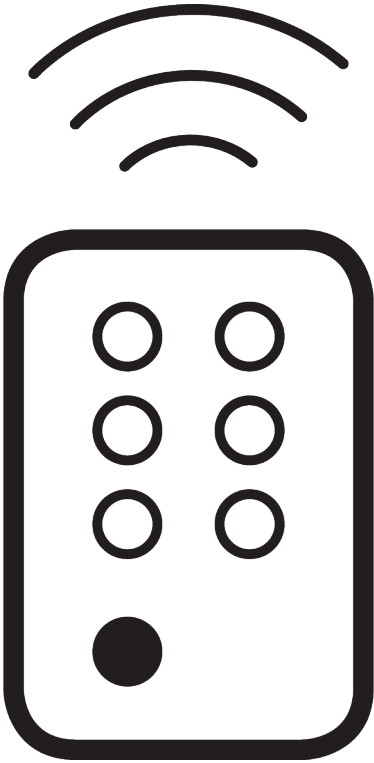

GENERAL NOTES

- *Installation by qualified fitter only.*
- *All radio installations must be installed according to local regulations.*
- *Electrical installations must be carried out according to Silent Gliss wiring diagrams.*
- *Check space for cables and plugs!*

APPLICATION CHART

<u>PAGE</u>	<u>SYSTEM</u>
5	SG Control A
11	SG Control L
19	SG Control R
25	SG Smart

SG Control A

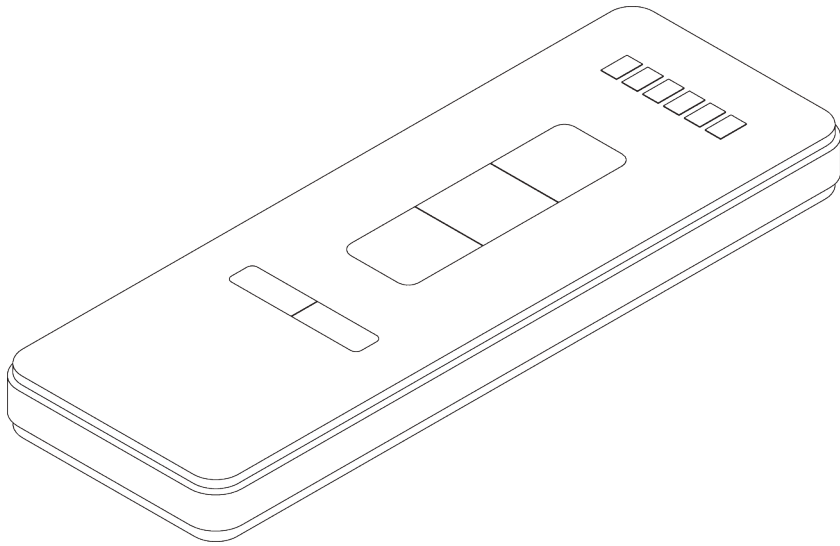

PRODUCT INFORMATION

- *Radio controlled*
- *1-channel, 2-channel, 5-channel or 6-channel radio controls*
- *Radio hand held and wall controls*
- *Single and multi channel timer units*

APPLICATION

A. SYSTEMS

- Electric curtain track system SG 5100
- Roller blind system SG 4955
- Roman blind system SG 2345

OVERVIEW COMPONENTS

A. RADIO CONTROLS

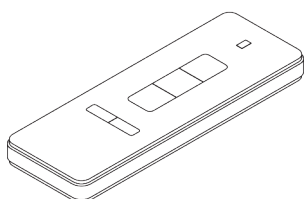

SG 10946

- **Channel:** 1 channel
- **Frequency:** 433.92 MHz
- **Colours:** white

Features:

- Operates single system or operates one group of systems

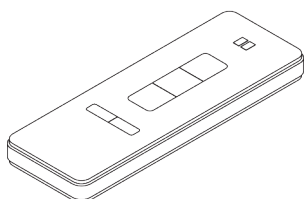

SG 10947

- **Channel:** 2+1 channel
- **Frequency:** 433.92 MHz
- **Colours:** white

Features:

- 2 channel: operates up to two single systems individually
- 2 channel: operates up to two groups of systems individually
- 1 channel: operates all systems together

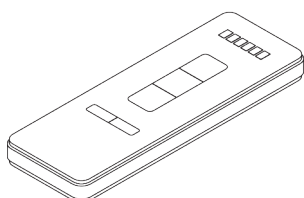

SG 10948

- **Channel:** 6+1 channel
- **Frequency:** 433.92 MHz
- **Colours:** white

Features:

- 6 channel: operates up to 6 single systems individually
- 6 channel: operates up to 6 groups of systems individually
- 1 channel: operates all systems together

B. RADIO WALL CONTROLS

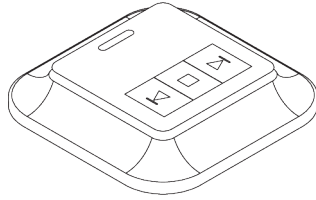

SG 10949

- **Channel:** 1 channel
- **Frequency:** 433.92 MHz
- **Colours:** white

Features:

- Operates single system or operates one group of systems

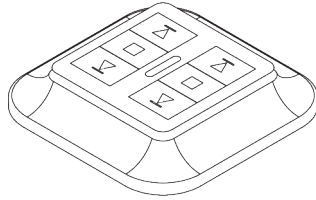

SG 10950

- **Channel:** 2 channel
- **Frequency:** 433.92 MHz
- **Colours:** white

Features:

- 2 channel: operates up to two single systems individually
- 2 channel: operates up to two groups of systems individually

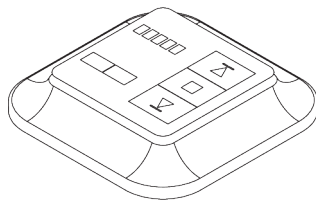

SG 10951

- **Channel:** 5+1 channel
- **Frequency:** 433.92 MHz
- **Colours:** white

Features:

- 5 channel: operates up to 5 single systems individually
- 5 channel: operates up to 5 groups of systems individually
- 1 channel: operates all systems together

C. RADIO TIMER UNITS

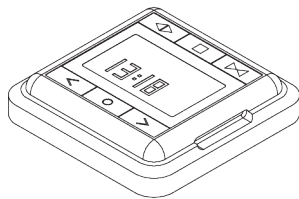

SG 11429

- **Channel:** 1 channel
- **Frequency:** 433.92 MHz
- **Colours:** white

Features:

- Operates single system
- Operates one group of systems
- LCD display
- Touch button control
- Single 'open' and 'close' time setting

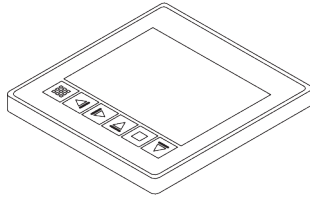

SG 11093

- **Channel:** 16 channel
- **Frequency:** 433.92 MHz
- **Colours:** white

Features:

- 16 channel: operates up to 16 single systems individually
- 16 channel: operates up to 16 groups of systems individually
- LCD display
- Touch button control
- Timing function with max. 8 timing points programmable for daily and weekly cycles

D. MANUALS

Refer to Silent Gliss website.

COMBINATION CONTROLS AND SYSTEMS

A. EXAMPLE

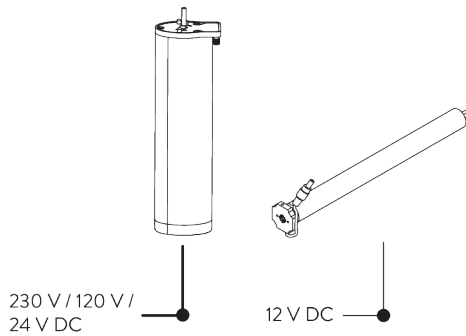

Applicable with following systems:

- Electric curtain track system SG 5100
- Roller blind system SG 4955
- Roman blind system SG 2345

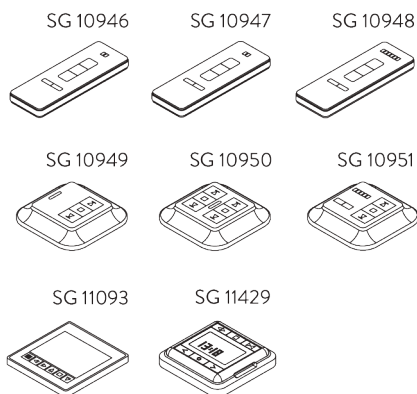

B. WIRING DIAGRAMS



Refer to Silent Gliss website.

PARTS

A. CONTROLS



SG 10946

Radio hand held 1 channel



SG 10947

Radio hand held 2+1 channel



SG 10948

Radio hand held 6+1 channel



SG 10949

Radio wall transmitter 1 channel



SG 10950

Radio wall transmitter 2 channel



SG 10951

Radio wall transmitter 5+1 channel

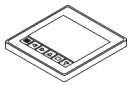

SG 11093

Radio timer unit 16 channel



SG 11429

Radio timer unit 1 channel

SG Control L

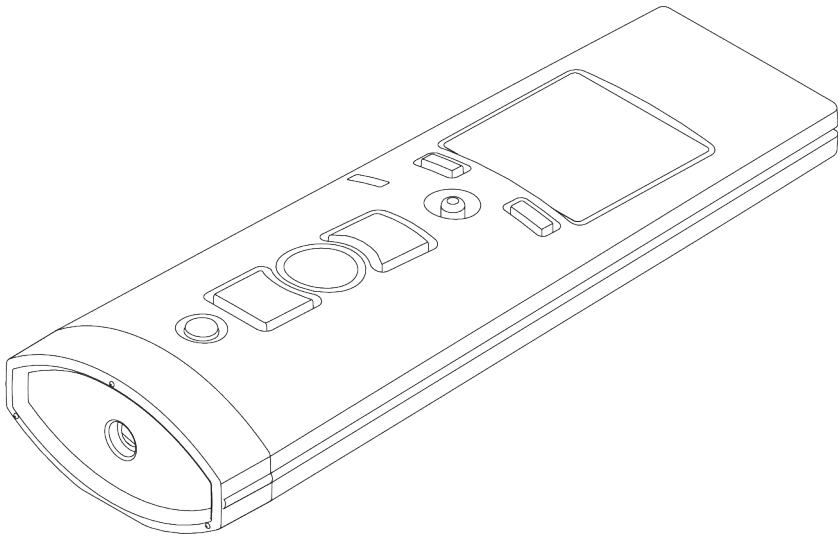

PRODUCT INFORMATION

- *Radio controlled*
- *Bi directional*
- *1-channel, 5-channel, 10-channel or 15-channel radio controls*
- *Radio hand held and wall controls*
- *Radio receivers for motors without integrated receiver*
- *Silent Gliss Move App*

APPLICATION

A. SYSTEMS

- Dim-out blind system SG 4760
- Dim-out blind system SG 4770
- Dim-out blind system SG 4780
- Electric curtain track system SG 5600
- Electric curtain track system SG 5800
- Panel Glide System SG 2750
- Pleated blind system SG 8500
- Roller blind system SG 4960
- Roller blind system SG 4970
- Roller blind system SG 4880
- Roman blind system SG 2350
- Skylight shading system SG 2195
- Skylight shading system SG 8600
- Skylight shading system SG 8640
- Venetian blind system SG 8250
- Venetian blind system SG 8960
- Vertical blind system SG 2950

OVERVIEW COMPONENTS

A. RADIO CONTROLS

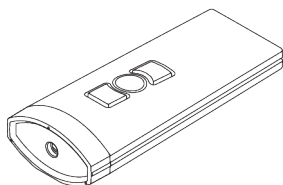

SG 10300

- **Channel:** 1 channel
- **Frequency:** 868 or 915 MHz
- **Colours:** white, silver and anthracite

Features:

- Operates single system or operates one group of systems
- Wall holder in corresponding colour

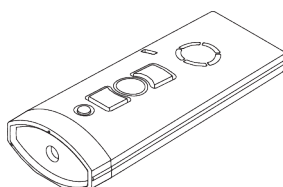

SG 10302

- **Channel:** 5+1 channel
- **Frequency:** 868 or 915 MHz
- **Colours:** white, silver and anthracite

Features:

- 5 channel: operates up to 5 single systems individually
- 5 channel: operates up to 5 groups of systems individually
- 1 channel: operates all systems together
- Wall holder in corresponding colour

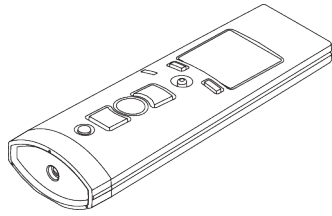

SG 10303

- **Channel:** 10+2+1 channel
- **Frequency:** 868 or 915 MHz
- **Colours:** white, silver and anthracite

Features:

- 10 channel: operates up to 10 single systems individually
- 10 channel: operates up to 10 groups of systems individually
- 2 channel: combines the 10 groups into 2 groups and operates them individually
- 1 channel: operates all systems together
- Various languages
- Programmable day and week, sunrise and sunset time
- Holiday mode
- Illuminated display
- Astro times
- Wall holder in corresponding colour

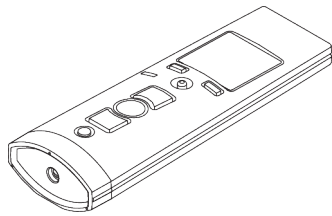

SG 10804

- Channel: 15+5+1 channel
- Frequency: 868 or 915 Mhz
- Colours: white, silver and anthracite

Features:

- 15 channel: operates up to 15 single systems individually
- 15 channel: operates up to 15 groups of systems individually
- 5 channel: combines the 15 groups into 5 groups and operates them individually
- 1 channel: operates all systems together
- Various languages
- Intelligent display management
- Wall holder in corresponding colour

B. RADIO WALL **CONTROLS**

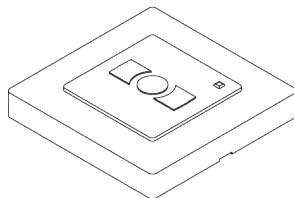

SG 11480

- **Channel:** 1 channel
- **Frequency:** 868 or 915 MHz
- **Colours:** white

Features:

- Operates single system or operates one group of systems

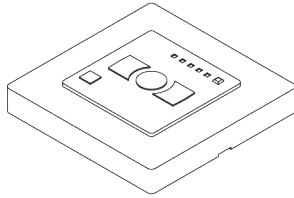

SG 11490

- **Channel:** 5+1 channel
- **Frequency:** 868 or 915 MHz
- **Colours:** white

Features:

- 5 channel: operates up to 5 single systems individually
- 5 channel: operates up to 5 groups of systems individually
- 1 channel: operates all systems together

C. MOVE BY SILENT GLISS

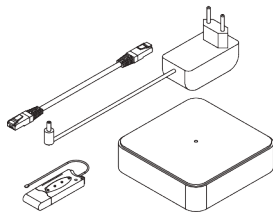

SG 9960

- **Channel:** 15 channel
- **Frequency:** 868 or 915 MHz
- **Colours:** black
- **Move server set:** consists of server and transmitter stick SG 9961

Features:

- Operates up to 15 single systems individually (per stick)
- Operates up to 15 groups of systems individually (per stick)
- Slot for two transmitter sticks SG 9961
- App available for Android and IOS
- Various languages
- "Scenes" programmable
- Programmable day and week, sunrise and sunset time
- Holiday mode
- Astro times

D. RADIO RECEIVERS

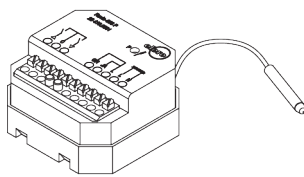

SG 9068

- **Channel:** 1 channel
- **Frequency:** 868 or 915 MHz
- **Voltage:** 230 or 120 V

Features:

- Operates single system
- Flush mounting

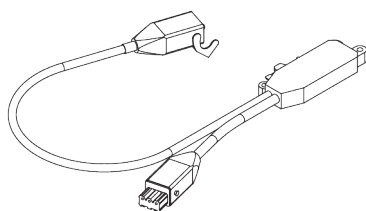

SG 9944

- **Channel:** 1 channel
- **Frequency:** 868 or 915 MHz
- **Voltage:** 230 or 120 V

Features:

- Operates single system
- Non latching mode

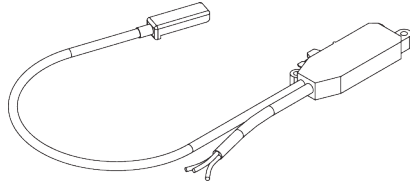
**SG 9945**

- **Channel:** 1 channel
- **Frequency:** 868 or 915 MHz
- **Voltage:** 230 or 120 V

Features:

- Operates single system
- Latching mode

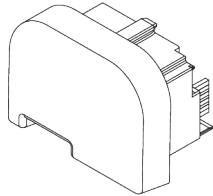
**SG 9063**

- **Channel:** 1 channel
- **Frequency:** 868 or 915 MHz

Features:

- Only applicable with motor SG 9060 (electric curtain track system SG 5600)

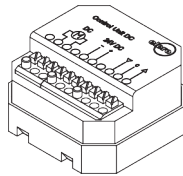
E. CONTROL UNIT**DC****SG 9947**

- **Voltage:** 24 V DC

Features:

- Relay
- Flush mounting
- Needed with SG 8250 or SG 8500

F. MANUALS

Refer to Silent Gliss website.

COMBINATION CONTROLS / RECEIVERS AND SYSTEMS

A. EXAMPLES

Motors with integrated receiver

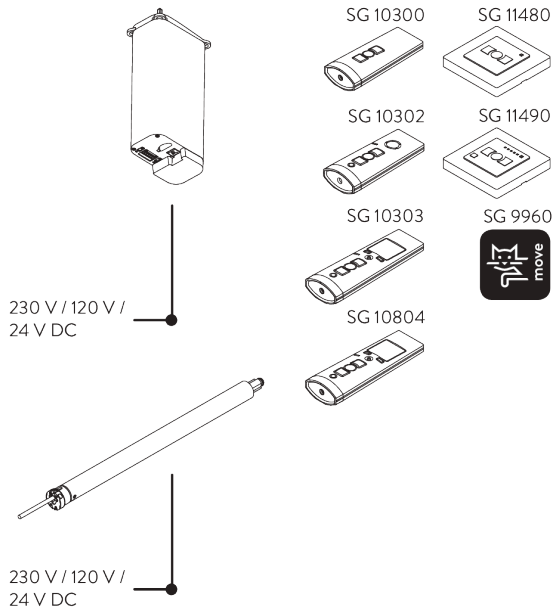

Applicable with following systems:

- Dim-out blind system SG 4760
- Dim-out blind system SG 4770
- Dim-out blind system SG 4780
- Electric curtain track system SG 5600
- Panel glide system SG 2750
- Roller blind system SG 4960
- Roller blind system SG 4970
- Roller blind system SG 4880
- Roman blind system SG 2350
- Vertical blind system SG 2950
- Venetian blind system SG 8960 (230 V)

Motors without integrated receiver

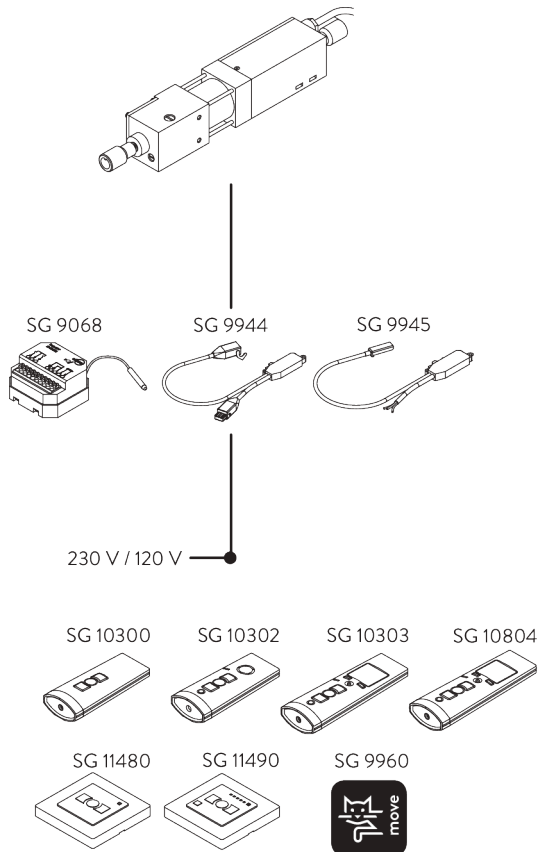

Applicable with following systems:

- Electric curtain track system SG 5800
- Skylight shading system SG 2195
- Skylight shading system SG 8600
- Skylight shading system SG 8640

**24 V DC motors
without integrated
receiver**

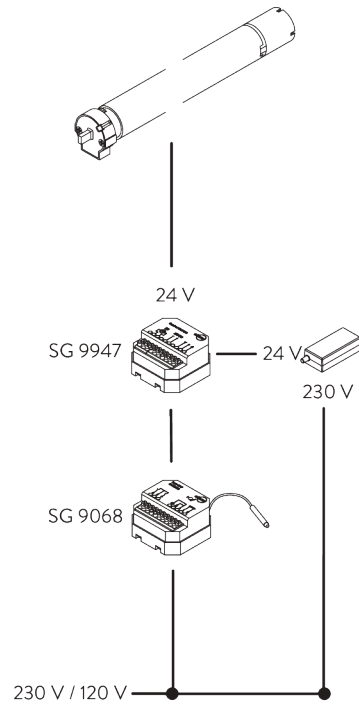

Applicable with following systems:

- Roller blind system SG 4960
- Pleated blind system SG 8500
- Venetian blind system SG 8250

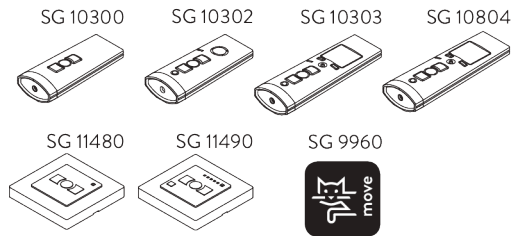

B. WIRING
DIAGRAMS



Refer to Silent Gliss website.

PARTS

A. CONTROLS / RECEIVERS

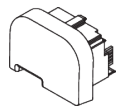

SG 9063

Radio module type L

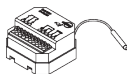

SG 9068

Radio receiver Revio

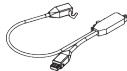

SG 9944

Radio receiver 1 channel

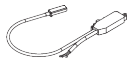

SG 9945

Radio receiver 1 channel

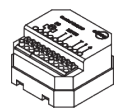

SG 9947

Control unit DC 24V

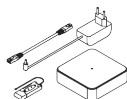

SG 9960

Move server set

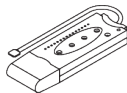

SG 9961

Move transmitter



SG 10300

Radio hand held 1 channel



SG 10302

Radio hand held 5+1 channel



SG 10303

Radio hand held 10+2+1 channel



SG 10804

Radio hand held 15+5+1 channel



SG 11480

Radio wall transmitter 1 channel



SG 11490

Radio wall transmitter 5+1 channel

SG Control R

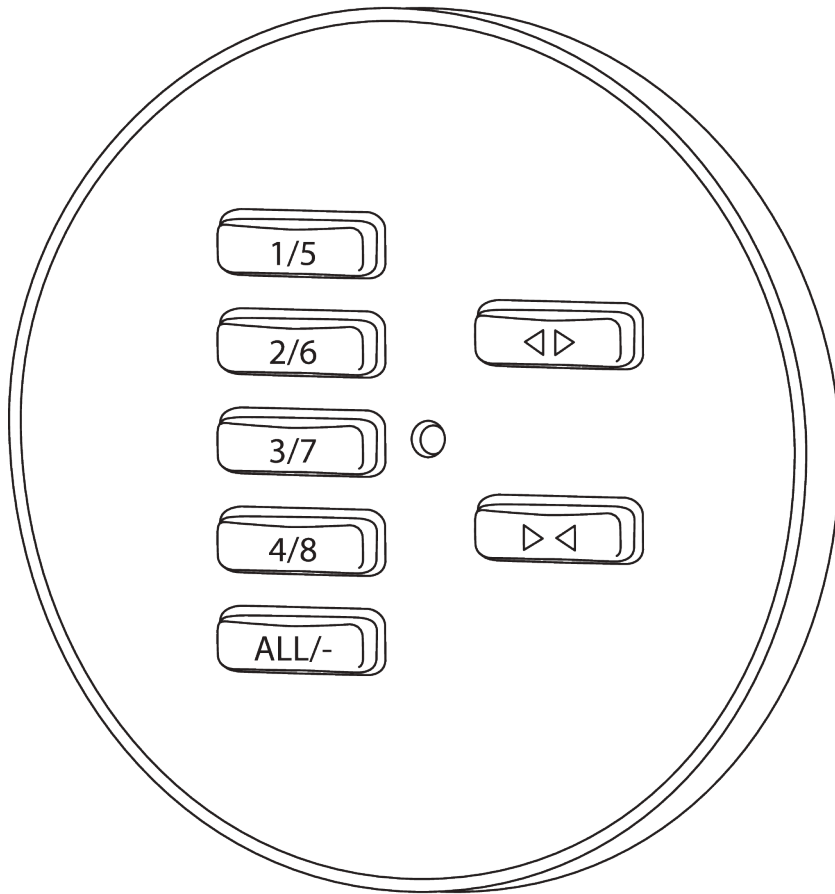

PRODUCT INFORMATION

- Radio controlled
- Single-channel and 8-channel radio controls
- Radio hand-held and wall mounted controls
- Radio receivers for motors without integrated receiver
- Wall switch finishes – mirror polish steel, stainless steel, brass

APPLICATION

A. SYSTEMS

- Dim-out blind system SG 4760
- Dim-out blind system SG 4770
- Dim-out blind system SG 4780
- Electric curtain track system SG 5600
- Electric curtain track system SG 5800
- Pleated blind system SG 8500
- Roller blinds system SG 4960
- Roller blinds system SG 4970
- Roller blinds system SG 4880
- Roman blind system SG 2350
- Skylight shading system SG 2195
- Skylight shading system SG 8640
- Skylight shading system SG 8600
- Venetian blind system SG 8250
- Venetian blind system SG 8960
- Vertical blind system SG 2950

OVERVIEW COMPONENTS

A. RADIO WALL CONTROLS

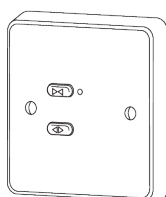

SG 20913

- **Channel:** 1 channel
- **Frequency:** 433.9 MHz
- **Colours:** Mirror polish steel, brushed stainless steel, brass

Features:

- Operates single system or one group of systems

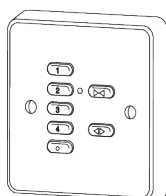

SG 20914

- **Channel:** 8 channel
- **Frequency:** 433.9 MHz
- **Colours:** Mirror polish, brushed stainless, brass

Features:

- 8 channel: operates up to 8 systems individually
- 8 channel: operates up to 8 groups of systems individually
- 1 channel operates all systems together

B. RADIO CONTROLS

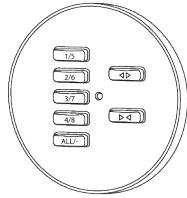

SG 20336

- **Channel:** 8 channel
- **Frequency:** 433.9 MHz
- **Colours:** Mirror polish steel, Brushed stainless steel, brass

Features:

- 8 channel: operates up to 8 systems individually
- 8 channel: operates up to 8 groups of systems individually
- 1 channel operates all systems together

C. RADIO RECEIVERS

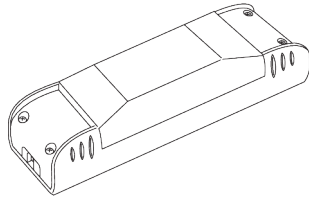

SG 20907

- **Channel:** 1 channel
- **Frequency:** 433.9 MHz
- **Voltage Input:** 24 V
- **Volt output :** 24 V

Features:

- Operates 24V single system
- For motors without integrated receiver

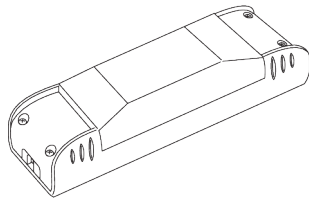

SG 20919

- **Channel:** 1 channel
- **Frequency:** 433.9 MHz
- **Voltage input:** 230 V
- **Voltage output:** 230V

Features:

- Operates 230 V single system
- For motors without integrated receiver

D. MANUALS

Refer to Silent Gliss website.

COMBINATION CONTROLS / RECEIVERS AND SYSTEMS

A. EXAMPLES

Motors with integrated receiver

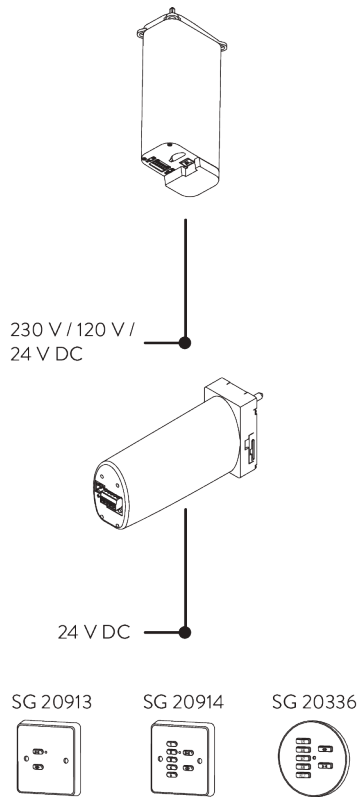

Applicable with the following systems:

- Electric curtain track system SG 5600
- Vertical blind system SG 2950

Motors without integrated receiver

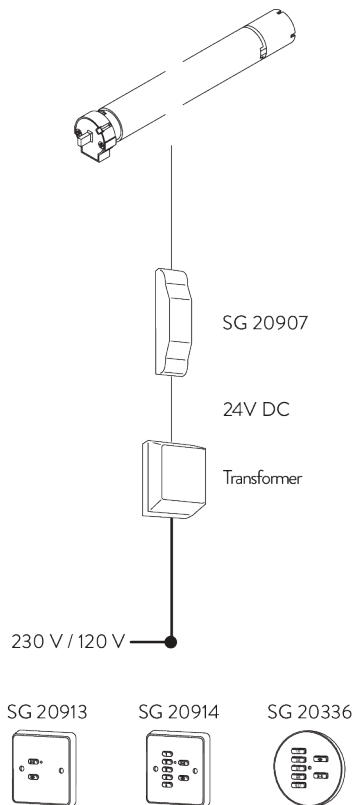

Applicable with the following systems:

- Pleated blind system SG 8500
- Venetian blind system SG 8250

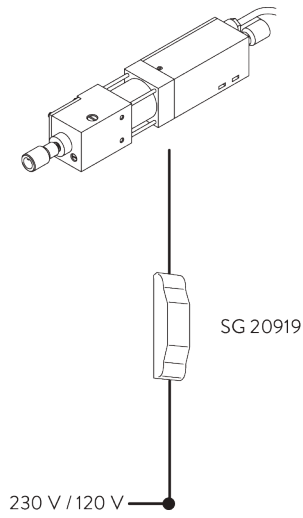

SG 20913



SG 20914



SG 20336



Applicable with the following systems:

- Dim-out blind system SG 4760
- Dim-out blind system SG 4770
- Dim-out blind system SG 4780
- Electric curtain track system SG 5800
- Roller blinds system SG 4960
- Roller blinds system SG 4970
- Roller blinds system SG 4880
- Roman blind system SG 2350
- Skylight shading system SG 2195
- Skylight shading system SG 8640
- Skylight shading system SG 8600

**B. WIRING
DIAGRAMS**



Refer to Silent Gliss website.

PARTS

A. CONTROLS / RECEIVERS

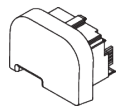

SG 11411

Radio module type R

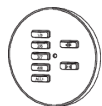

SG 20336

Hand held transmitter 8 channel

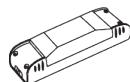

SG 20907

Control module motor type R

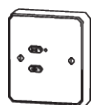

SG 20913

Wall switch single channel

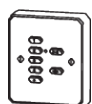

SG 20914

Wall switch 8 channel

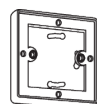

SG 20917

Pattness box

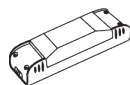

SG 20919

Control module motor type R

SG Smart

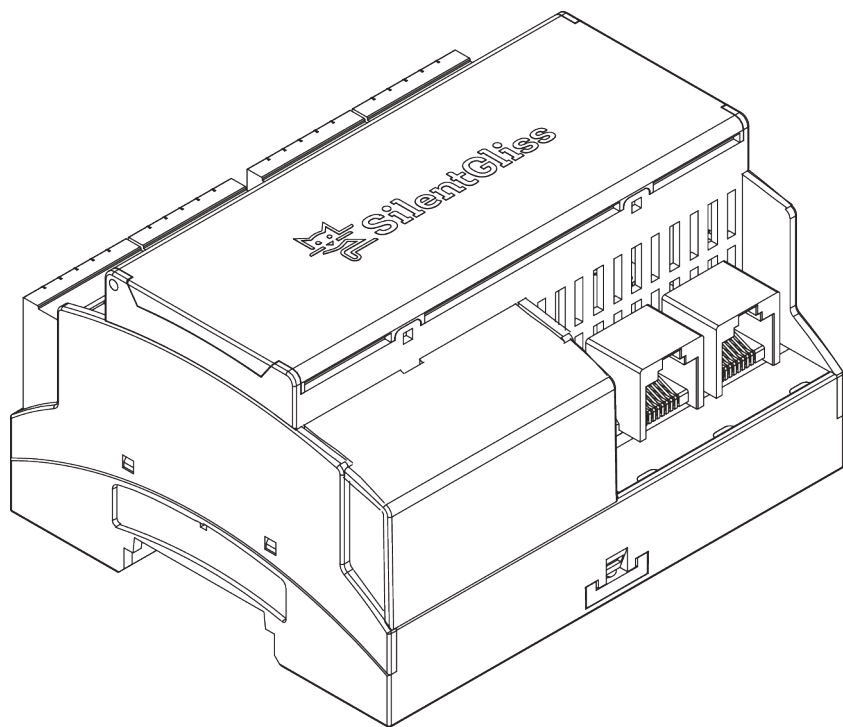

PRODUCT INFORMATION

- Full two way communication between motors and control system
- Works in conjunction with specific third party control systems
- Precise motor control
- Wide range of Silent Gliss product types

APPLICATION

A. SYSTEMS

- Dim-out blind system SG 4760
- Dim-out blind system SG 4770
- Dim-out blind system SG 4780
- Electric curtain track system SG 5600
- Roller blind system SG 4960
- Roller blind system SG 4970
- Roller blind system SG 4880
- Roman blind system SG 2350

OVERVIEW COMPONENTS

A. SMART COMPONENTS

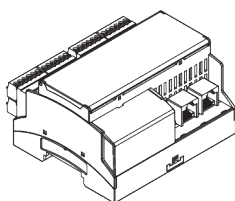

SG 11260 Gateway

- Din rail mounted

Features:

- Controls up to 8 motors
- Up to 64 motors when combined with Expansion Units SG 11262
- Key communication link with primary control system
- Plug in connector blocks

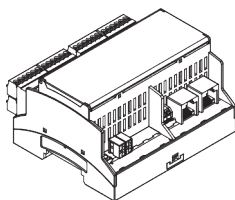

SG 11261 Gateway KNX

- Din rail mounted

Features:

- For use with KNX based control systems
- Key communication link with primary control systems
- Controls up to 8 motors
- Up to 64 motors when combined with expansion units SG 11262
- Plug in connector blocks

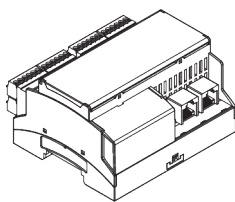

SG 11262 Expansion Unit

- Din Rail mounted
- Used in conjunction with Gateways

Features:

- Controls up to 8 motors
- Plug in connector blocks

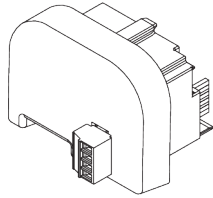

SG 11270

- Smart Module for SG 5600 system
- Works exclusively with Smart Gateway components

Features:

- Simple "plug in" module for SG 9060 motors
- Screw connector blocks

B. POWER SUPPLIES

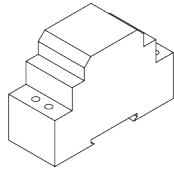

SG 11263

- 24 V DC 1.5 A output
- Din rail mounted

Features:

- Powers Gateway components SG 11260 / SG 11261
- Variable input voltage
- Output range 21.6 - 29 V DC

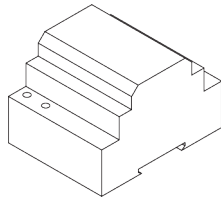

SG 11264

- 24 V DC 3.8 A output
- Din Rail mounted

Features:

- Variable input voltage
- Output range 21.6 - 29 V DC

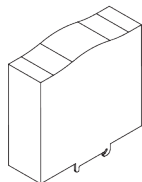

SG 11265

- 24 V DC 5 A output
- Din rail mounted

Features:

- Variable input voltage
- Output range 24 - 28 V DC

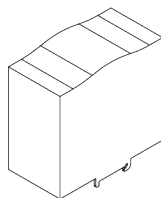

SG 11266

- 24 V DC 10 A output
- Din rail mounted

Features:

- Variable input voltage
- Output range 24 - 28 V DC

C. CABINETS

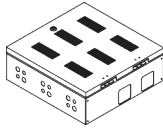

SG 11281

- 8 system cabinet

Features:

- Takes up to 8 smart product systems
- Steel construction
- Wall mounted
- Size 520 mm W x 510 mm L x 196.5 mm D
- Complete with 100 A mains power breaker

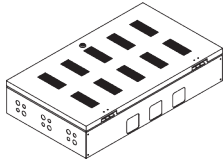

SG 11282

- 24 system cabinet

Features:

- Takes up to 24 smart product systems
- Steel construction
- Size 520 mm W x 890 mm L x 196.5 mm D
- Complete with 100 A mains power breaker

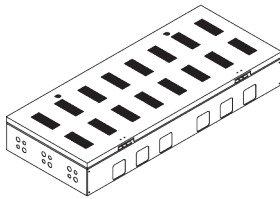

SG 11283

- 56 system cabinet

Features:

- Takes up to 56 smart product systems
- Steel construction
- Size 520 mm W x 1250 mm L x 196.5 mm D
- Complete with 100 A mains power breaker

D. MANUALS

Refer to Silent Gliss website.

COMBINATION CONTROLS AND SYSTEMS

A. EXAMPLE

Schematic Smart system arrangement

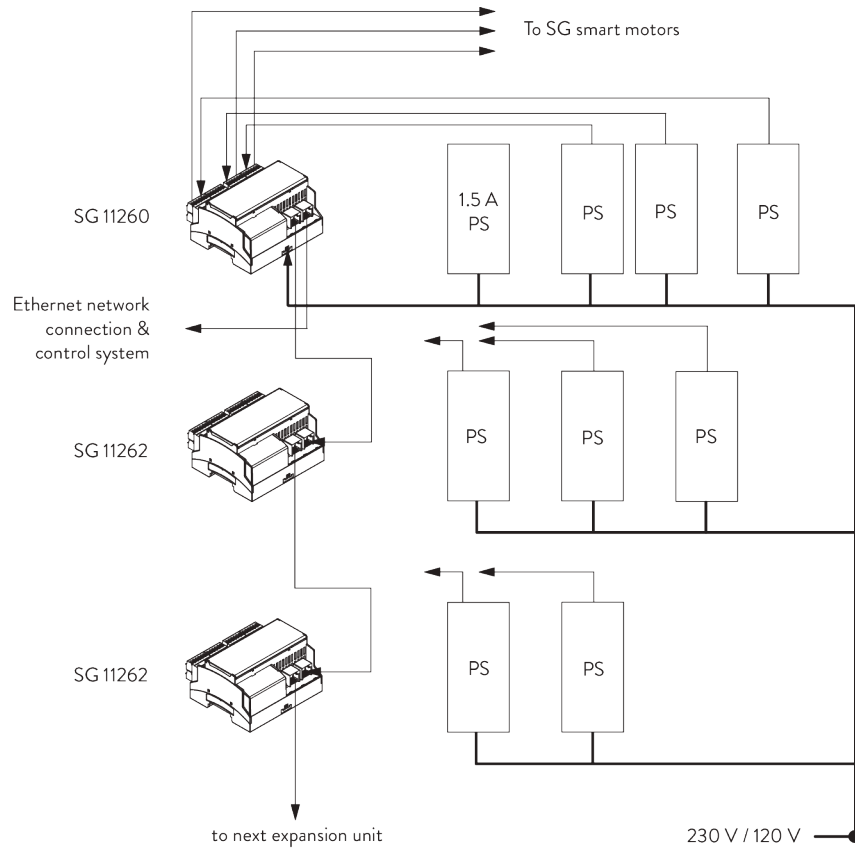

B. WIRING DIAGRAMS



Refer to Silent Gliss website.

PARTS

A. CONTROLS



SG 11250

Smart motor 24V DC, 50-Series
1.5/55



SG 11251

Tubular motor 24V DC, 50-Series
3/32



SG 11252

Tubular motor 24V DC, 50-Series
6/20



SG 11255

Tubular motor 24V DC, 50-Series
10/20

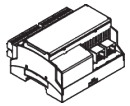

SG 11260

Smart controller gateway unit

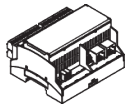

SG 11261

Smart controller gateway unit KNX

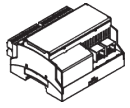

SG 11262

Smart controller expansion unit

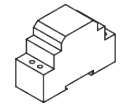

SG 11263

Power supply 24V DC, 2 Ampere
DIN Rail

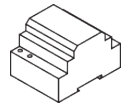

SG 11264

Power supply 24V DC, 3.8 Ampere
DIN Rail

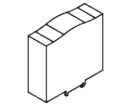

SG 11265

Power supply 24V DC, 5 Ampere
DIN Rail

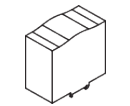

SG 11266

Power supply 24V DC, 10 Ampere
DIN Rail

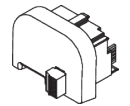

SG 11270

Smart module

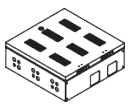

SG 11281

Cabinet for 8 systems

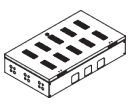

SG 11282

Cabinet for 24 systems

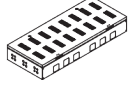

SG 11283

Cabinet for 56 systems



SG 11325

Smart plug 6-pin, MC 1.5/6 ST-3.81

The Architects of Silence

Silent Gliss is the leading global supplier of premium interior window treatments. Since 1952 we have been tirelessly committed to the development of the world's smoothest, quietest systems using state of the art technology.

Driven by customer needs, Silent Gliss offers functional and durable products. Expert technical advice coupled with installation and support services complete the offer. Silent Gliss stands for innovative, sustainable, tailor made solutions, exceptional design and first-class quality.

Silent Gliss Ltd.

Pyramid Business Park
Poorhole Lane, Broadstairs
Kent CT10 2PT
United Kingdom
T +44 1843 863571
F +44 1843 864503
info@silentgliss.co.uk

Silent Gliss Global Ltd.

Pyramid Business Park
Poorhole Lane, Broadstairs
Kent CT10 2PT
United Kingdom
T +44 1843 874250
F +44 1843 864503
info@silentglissglobal.com

Silent Gliss Blinds Trading LLC

Office 1906
The H Hotel Complex
Trade Center First
Dubai
United Arab Emirates
T +971 4 7050318
info@silentgliss.ae

silentgliss.co.uk
silentglissglobal.com
silentgliss.ae